

Matic

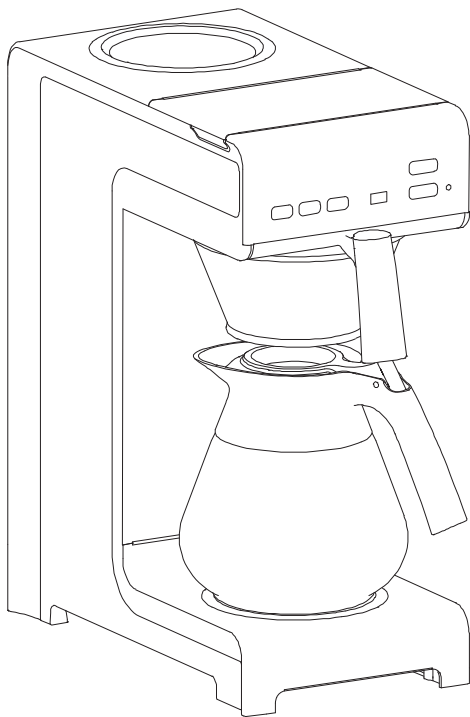

Matic

Model nr.: • MTCx-0xx
• MTCTW-0xx

User manual
Mode d'emploi Utilisateur
Gebraucher Handbuch
Gebruiksaanwijzing
Användarmanualen
Brukerhåndbok
Brugsanvisningen
Käyttäjän käsikirja
Manual del usuario
Manual do utilizador
Manuale per l'utente
Εγχειρίδιο χρήσης
Prostudujte uživatelskou
Podręcznik użytkownika
Manualul utilizatorului
Руководство пользователя
Kullanıcı kılavuzu
使用者手冊
ユーザーマニュアル
사용자 설명서

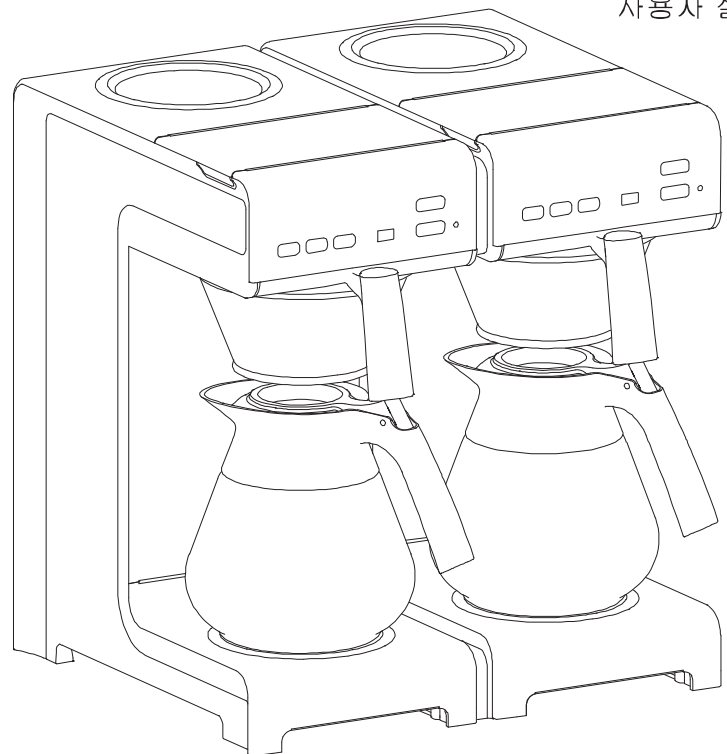

**Matic
Twin**



English
Français
Deutsch
Nederlands
Svenska



Norsk
Dansk
Suomi
Español
Português

Italiano
Ελληνικά
Česky
Polski
Română



Русский
Türkçe
Հայերեն
한국어

Safety book
Sommaire des sécurités
Sicherheitsvorschriften
Veiligheidsboek
Säkerhetsföreskrifter



Sikkerhedsbok
Sikkerhedsbog
Turvallisuuohjeet
Libro de seguridad
Instruções de segurança

Accessories
Accessoires
Zubehör
Toebehoren
Tillbehör



Tilbehør
Valgbar
Lisälaitteet
Accesorios
Acessórios

Wait
Patienter
Warten
Wachten
Vänta



Vent
Vent
Odota
Esperar
Aguardar

Rinse
Rinçer
Spülen
Afspoelen
Sköjning



Skylle
Rensning
Huuhtelee
Aclarar
Enxaguamento

Safety gloves
Gants de sécurité
Schutzhandschuh
Veiligheidshandschoenen
Skydds handskar



Hansker
Sikkerheds handsker
Suojahanskat
Zapatos de seguridad
Luvas de protecção

Safety goggles
Lunettes de sécurité
Schutzbrille
Veiligheidsbril
Skydds glasögon



Vernebriller
Sikkerhedsbriller
Suojalasit
Gafas de seguridad
Óculos de protecção

Dishwasher proof
Lave-vaisselle autorisé
Geschirrspülertauglich
Vaattwasmaschine
bestandig
Tål maskindisk



Tåler oppvaskmaskin
Maskinopvaske bestandig
Astianpesukoneen kestävä
Rest. para lavaplatos
À prova de máquina de lavar
louça

Moist cloth
Chiffon humide
Feuchtes Tuch
Vochtige doek
Fuktig trasa



Fuktig klut
Fugtig klud
Kosteä pyyhe
Trapo húmedo
Pano húmido

Call distributor
Appelez votre distributeur
Händler anrufen
Verkoopkantoor bellen
Ring Leverantör



Ring leverandør
Tilkald forhandler
Soita jälleenmyyjälle
Llame al distribuidor
Contacto importador

Prescrizioni di sicurezza
Εντυπο ασφαλείας
Bezpečnostní kniha
Wskazówki bezpieczeństwa
Carte instructaj



Инструкция по эксплуатации
Güvenlik kitabı
安全冊子
安全說明書
안전 지침서

Accessori
Εξαρτήματα
Příslušenství
Akcesoria
Accesorii



Аксессуары
Aksesuarlar
附件
備品
악세서리

Attendere
Αγαμονή
Čekejte
Czekaj
Aşteaptă



Ждите
Bekle
等待
待つ
기다림

Lavaggio
Ελαφριά πλύση
Vypláchnout
Plukanie
Clătire



Прополоскать
Durula
沖洗
すすぐ
세척

Guanti di protezione
Γάντια ασφαλείας
Ochranné rukavice
Rękawiczki ochronne
Mānuši protectje



Защитные перчатки
Güvenlik eldivenleri
安全手套
安全手袋
안전용 장갑

Occhiali di protezione
Γυαλιά ασφαλείας
Ochranné brýle
Okulary ochronne
Ochelari protectje



Защитные очки
Güvenlik gözlükleri
護目鏡
安全眼鏡
안전용 안경

Idoneo per lavastoviglie
Εγγυημένο για χρήση σε
πλυντήριο πιάτων
Myčka –důkaz
Mycie w zmywarce
dozwolone
Spálátor veselá



Допускается чистка в
посудомоечной машине
Bulaşık makinası uyumlu
可放於洗碗碟機清洗
食器洗い機で使用可能
접시세척기 사용금지

Panno umido
Υγρό πανί
Vlhká látka
Wilgotna szmatka
Cârpă umedă



Влажная салфетка
Nemli bez
濕布
濕った布
젖은헝겂

Chiamare il fornitore
Καλέστε τον αντιπρόσωπο /
διανομέα
Volejte dodavatele
Teefon do dystrybutora
Cheamă distribuitorul



Позвоните
дистрибутору
Çağrı distribütörü
聯絡經銷商
販売店に連絡して下さい
전화 교환기



English
Français
Deutsch
Nederlands
Svenska



Norsk
Dansk
Suomi
Español
Português

Italiano
Ελληνικά
Česky
Polski
Română



Русский
Türkçe
정보
說明

Information
Information
Information
Informatie
Information



Informasjon
Information
Informaatio
Información
Informação

Installation
Installation
Installation
Installieren
Installation



Installasjon
Installation
Asennus
Instalar
Instalação

Handling
Fonctionnement
Bedienung
Bedienen
Handhavande



Beþjening
Beþjening
Käsittely
Operación
Execução

Cleaning
Nettoyage
Reinigung
Schoonmaken
Rengöring



Vasking
Rengöring
Puhdistus
Limpiar
Limpeza

Descaling
Détartrage
Entkalkung
Ontkalken
Avkalkning



Rensing
Afkalkning
Kalkinpoisto
Descalcificación
Descalcificação

Programming
Programmation
Programmieren
Programmeren
Programmering



Programmering
Programmering
Ohjelmointi
Programar
Programação

Messages
Messages
Meldungen
Meldingen
Meddelanden



Meldinger
Beskeder
Viestit
Mensajes
Mensagens

Informazione
Πληροφορίες
Informace
Informacja
Informație



Информация
Bilgi
資料
情報
알림

Installazione
Εγκατάσταση
Instalace
Instalacja
Operare



Установка
Yerleştirme
安裝
設置
설치

Istruzione d'uso
Χειρισμός
Obsluha
Instrukcja obsługi
Instalare



Обслуживание
Kullanım
操作
取り扱い
취급

Pulizia
Καθαρισμός
Čištění
Czyszczenie
Curățare



Чистка
Temizleme
清洗
洗淨
청소

Decalcificazione
Αφαλάτωση
Odvápnění
Odkamienianie
Decalcarizare



Чистка от накипи
Kireçten arındırma
除垢
데스케일
스케일 청소

Programmazione
Προγραμματισμός λειτουργίας
Programování
Programowanie
Programare



Программирование
Programlama
程式
プログラミング
프로그램

Messaggio
Μηνύματα
Zprávy
Wiadomości
Mesaje



Сообщения
Mesajlar
信息
メッセージ
메세지



700.403.347

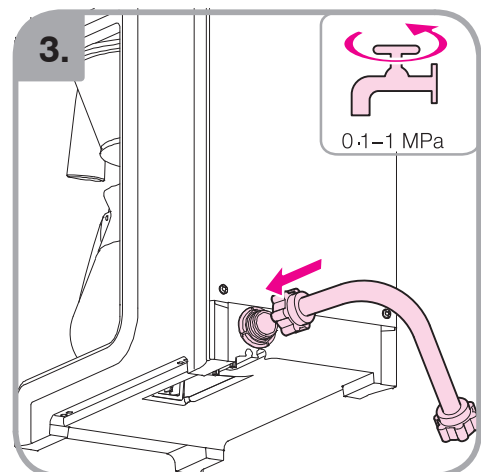
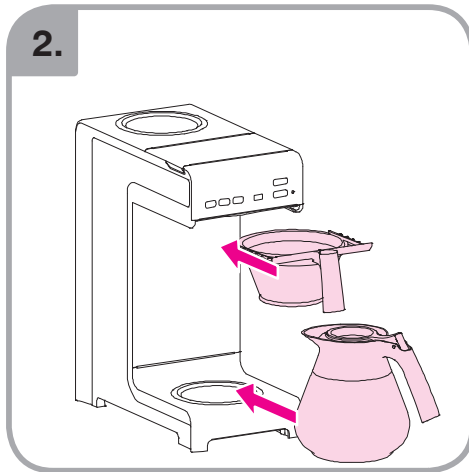

700.403.347

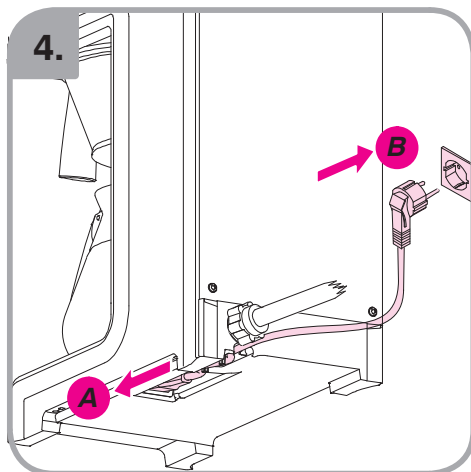

700.403.347

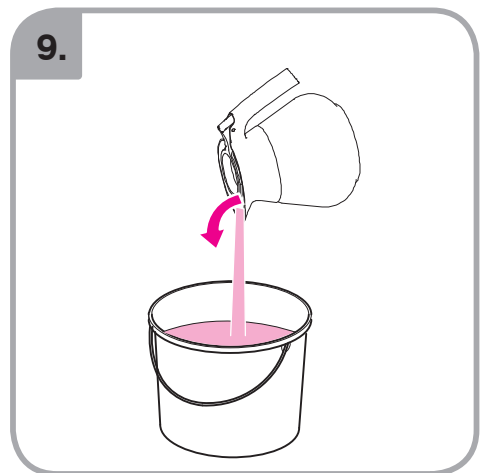
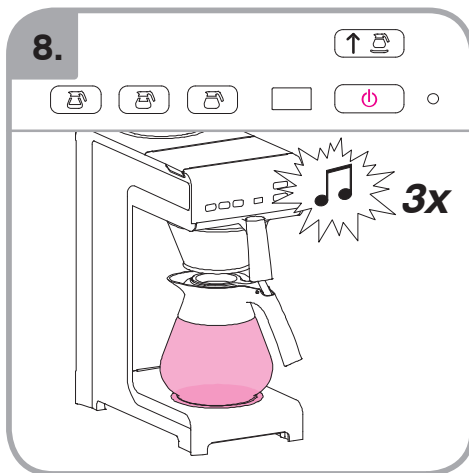
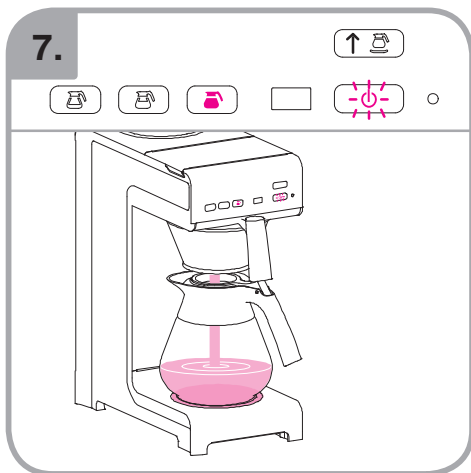
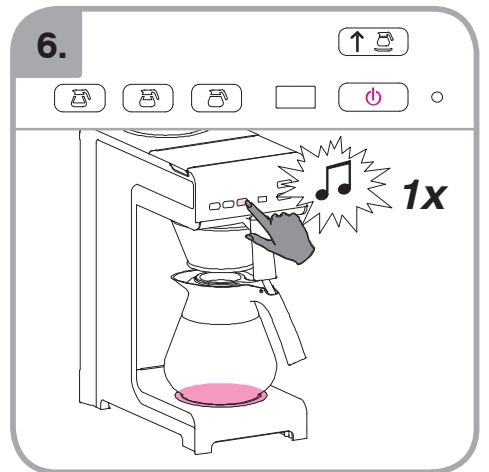
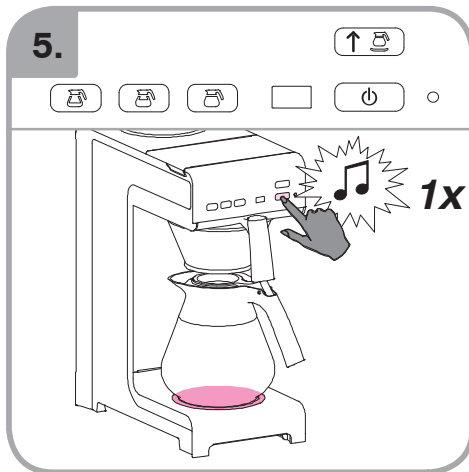





1.

≈ 40 g
35-50 g/L

=1.6 L
=0.8 L
=0.4 L

2.

3.



4.

1x

5.

1x

6.



7.

3x

8.

9.



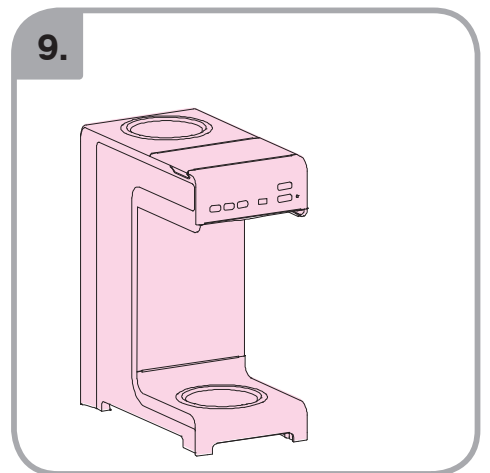
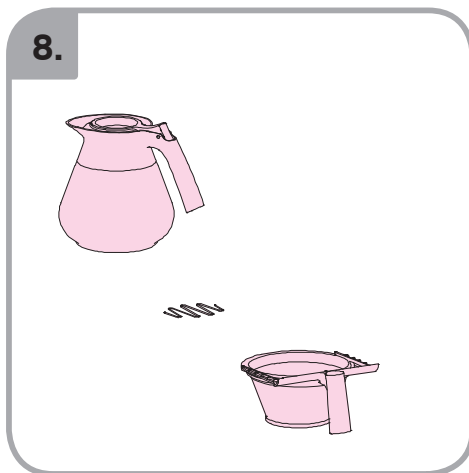
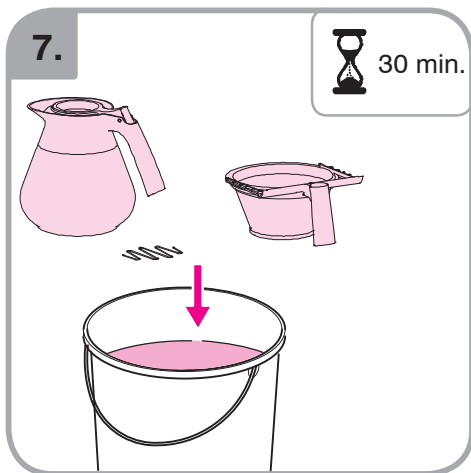
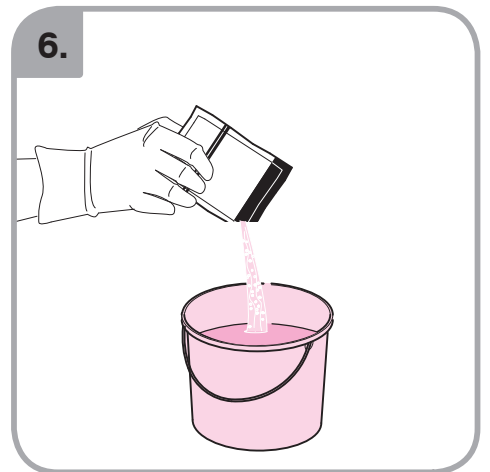
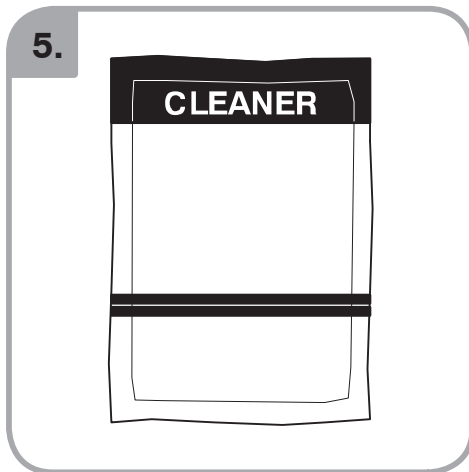
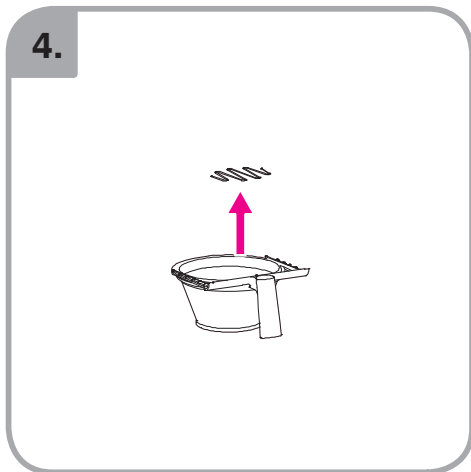
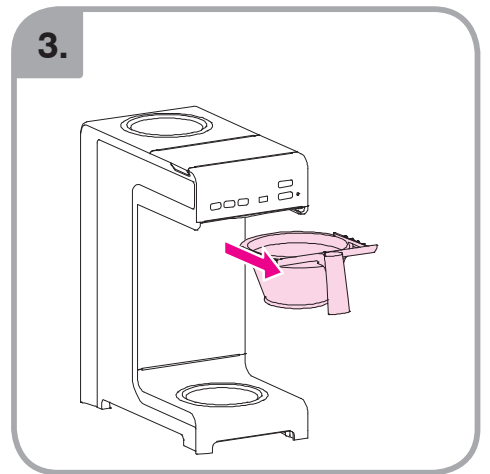
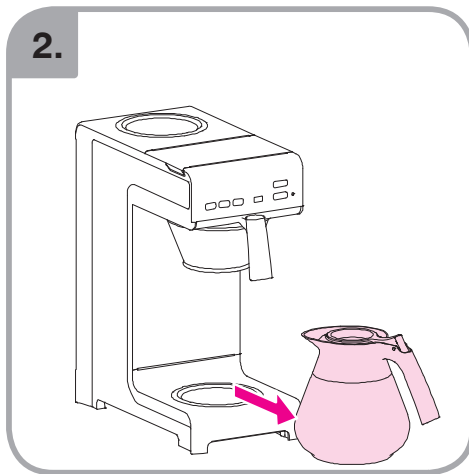
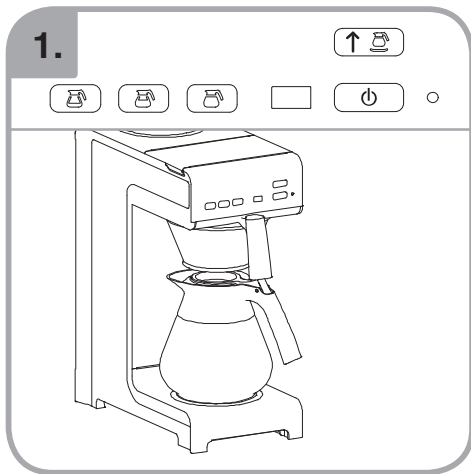



10.

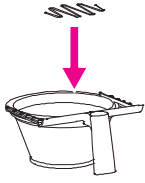

11.

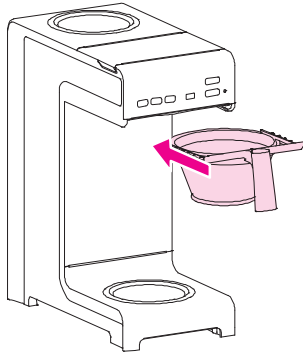

12.

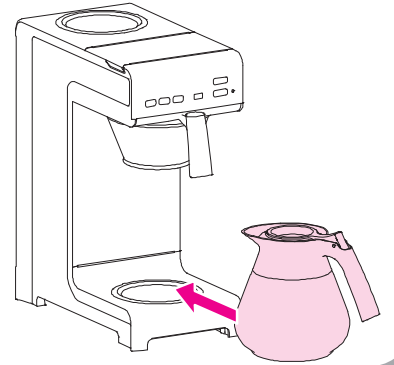

13.

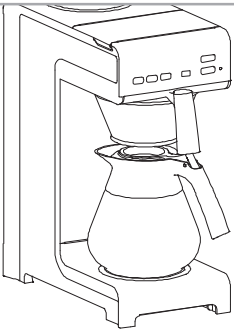

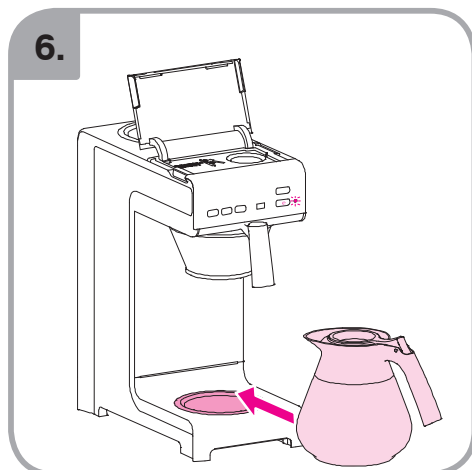
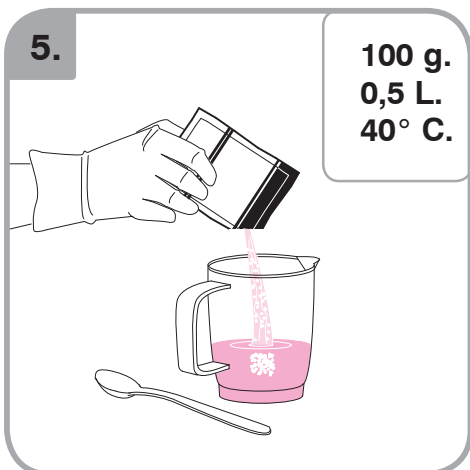
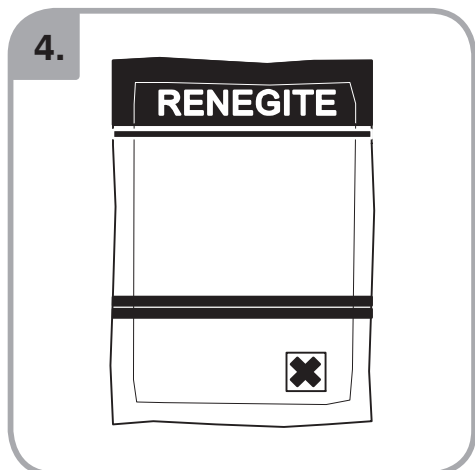
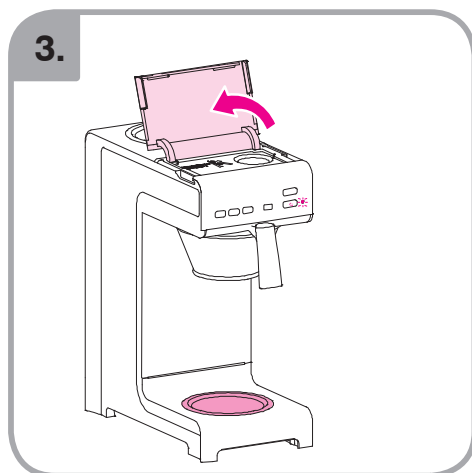
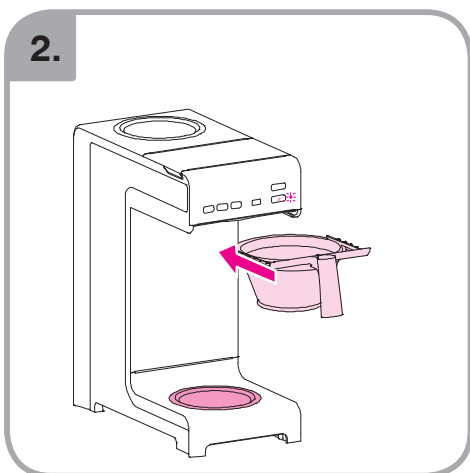
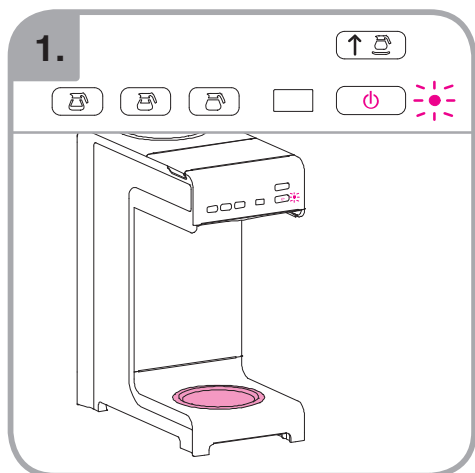

700.403.347

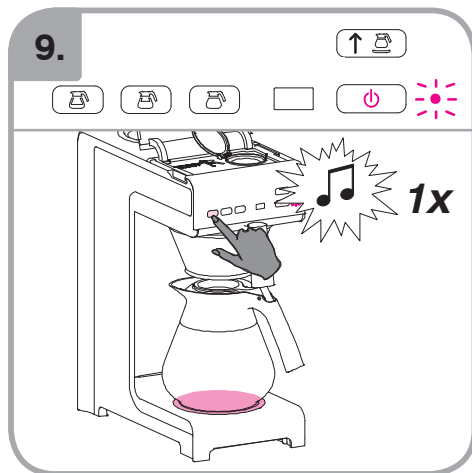
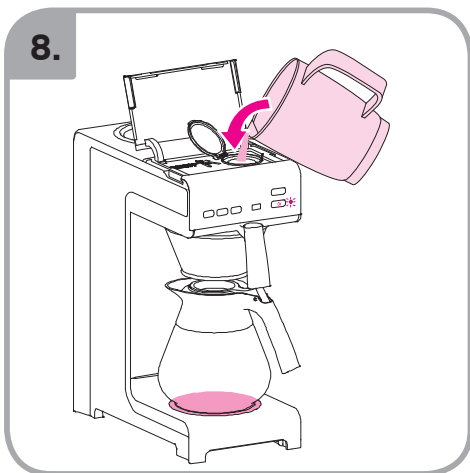
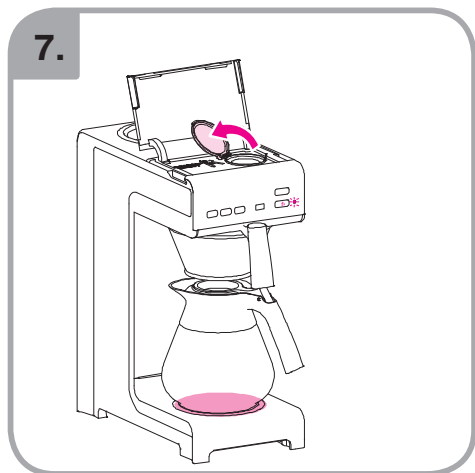

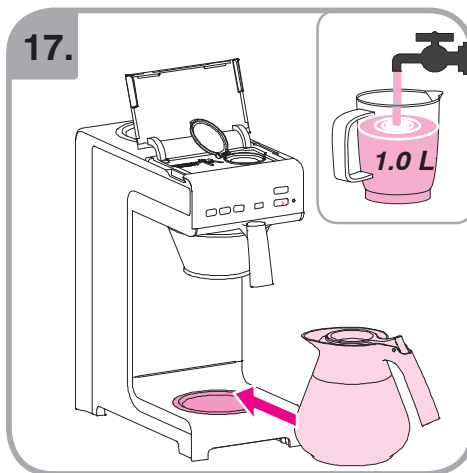
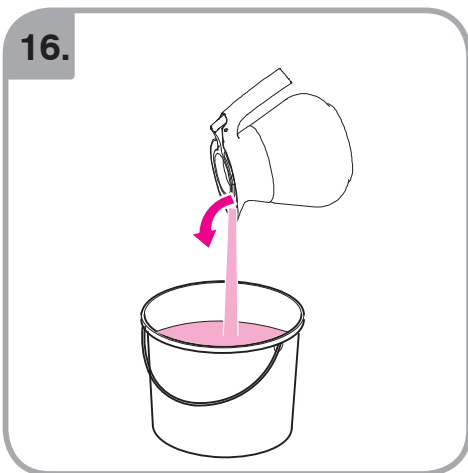
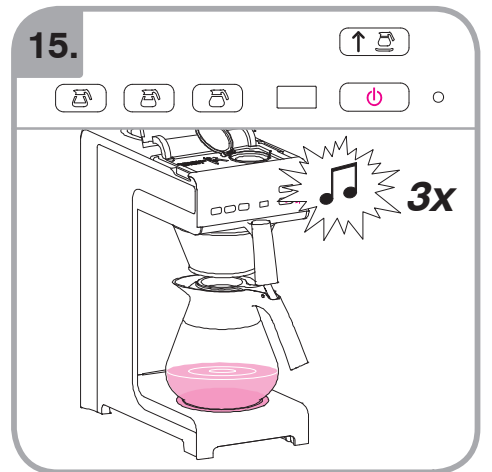
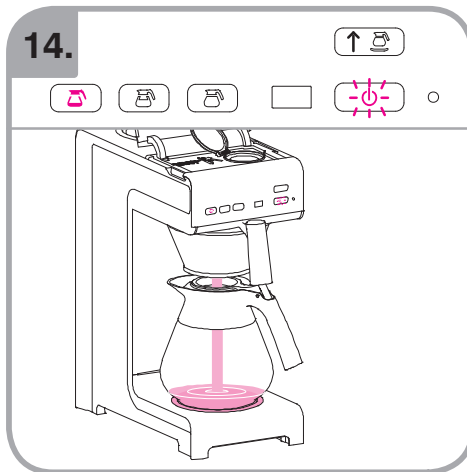
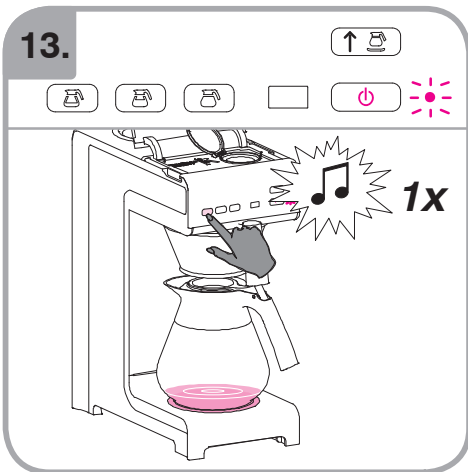
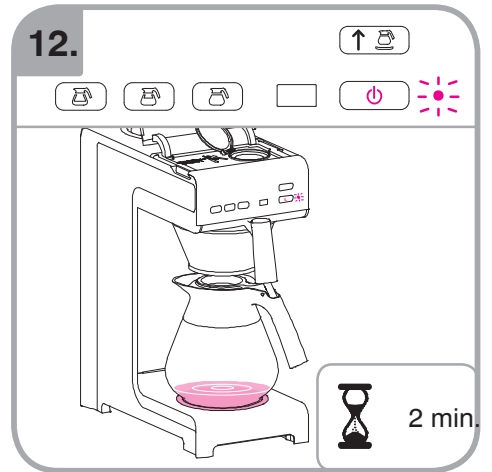
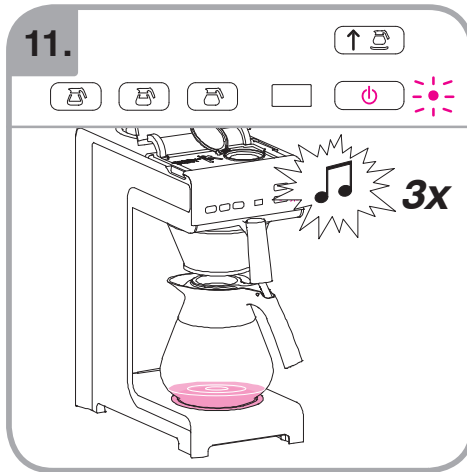
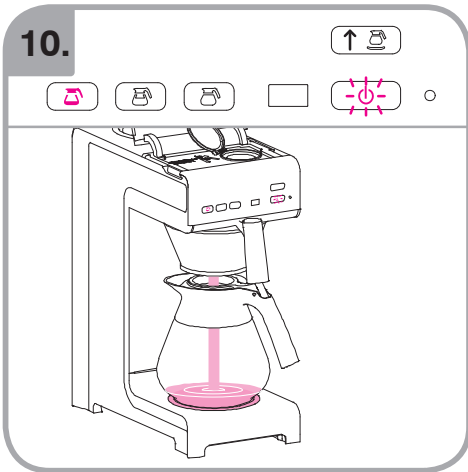

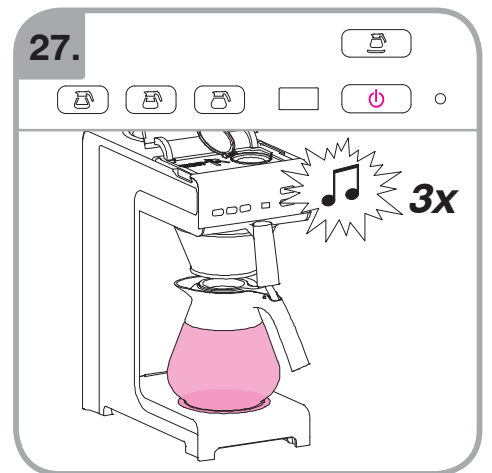
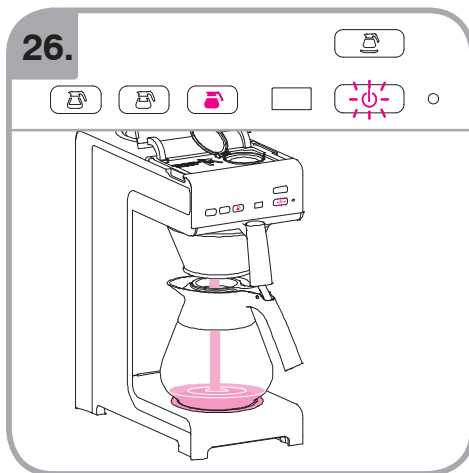
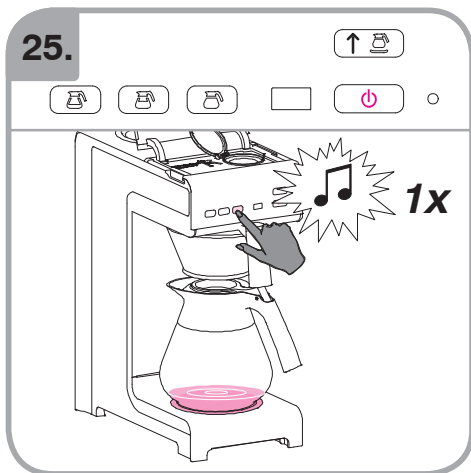
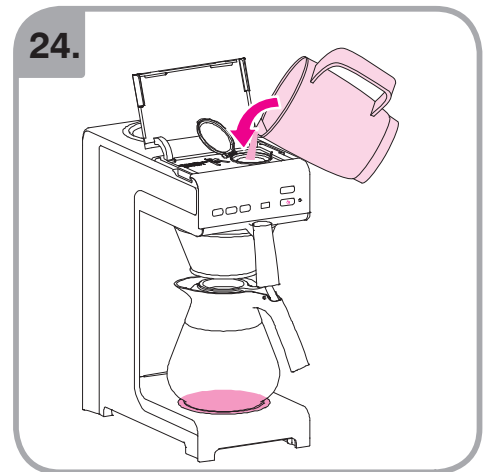
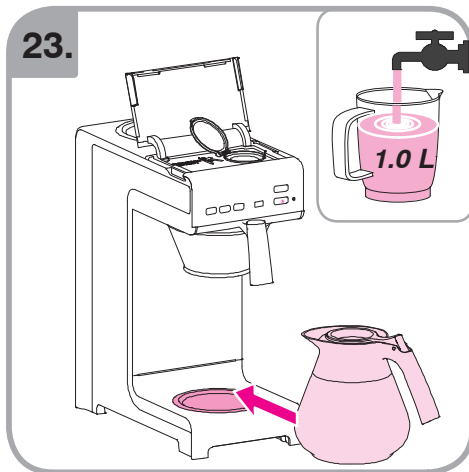
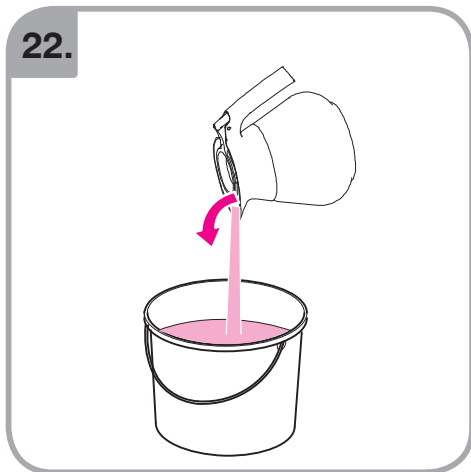
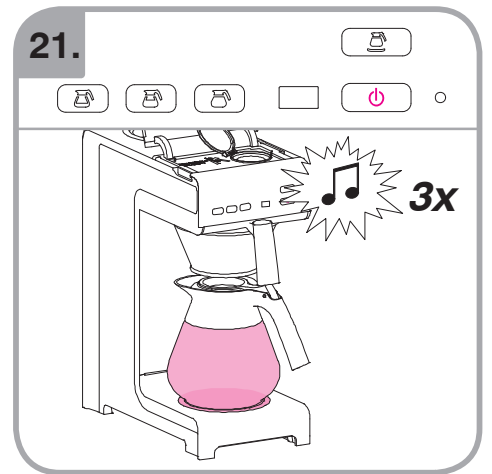
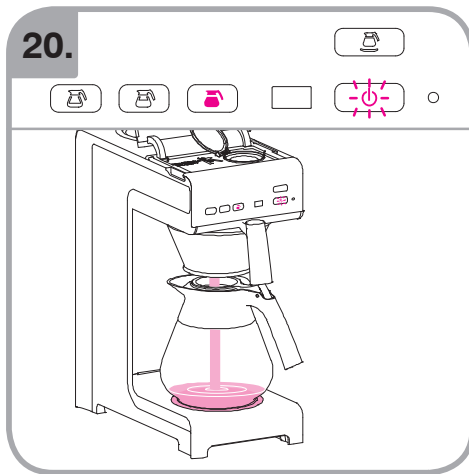
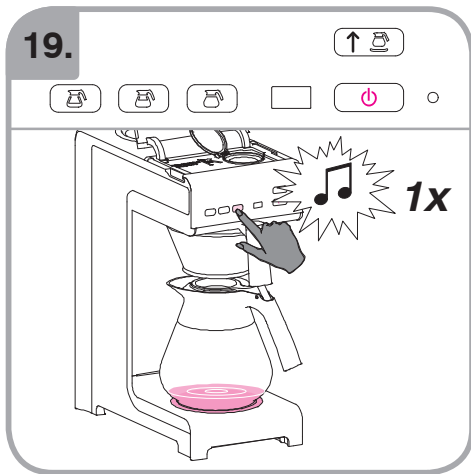



28.

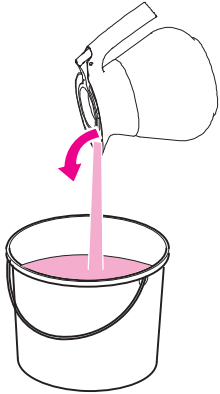

29.

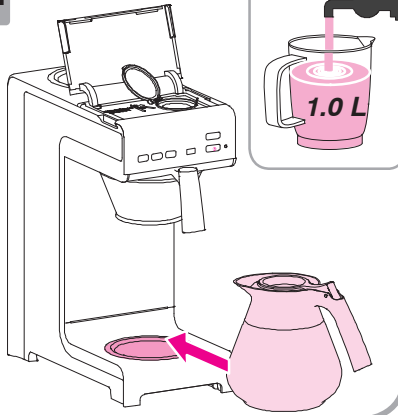

30.

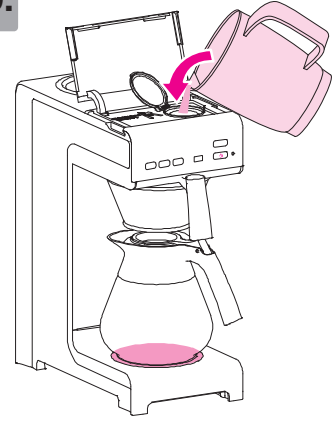

31.

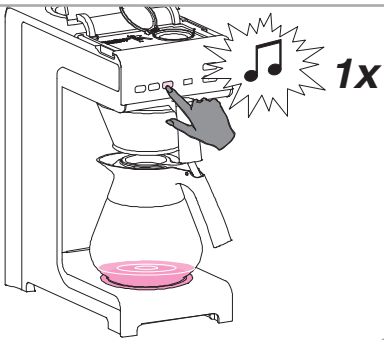

32.

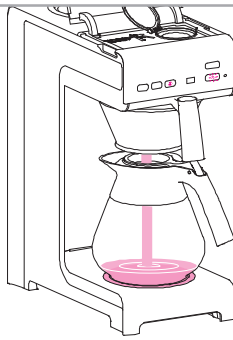

33.

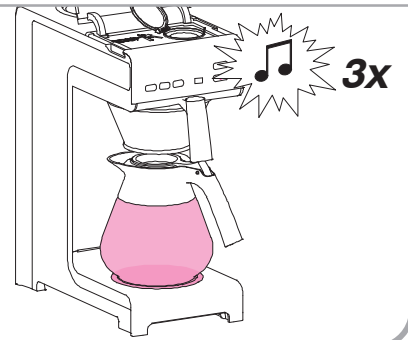

34.

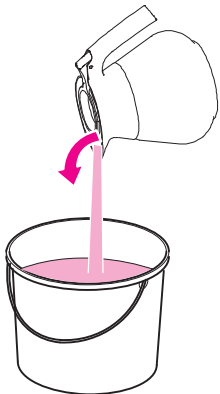

35.

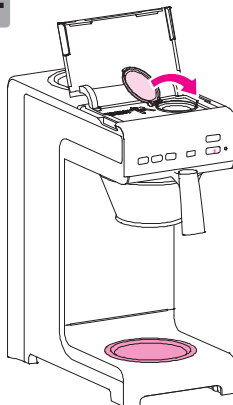

36.

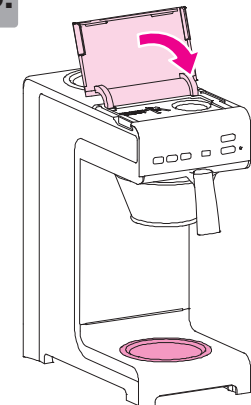

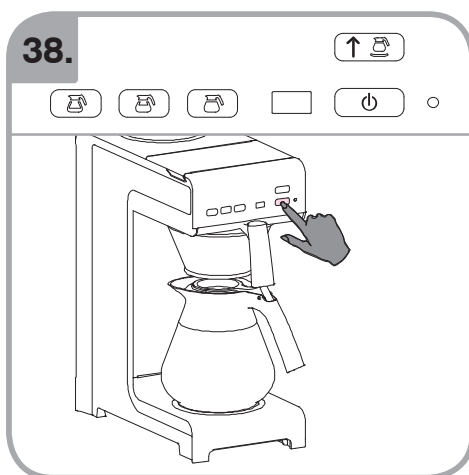
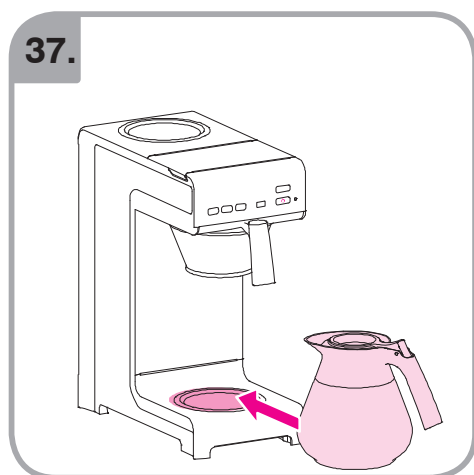



	□	▲	■	←	“ 580”	“x.x L”
English	Minimum value	Standard value	Maximum value	Confirm	Counter	Amount
Français	Valeur minimum	Valeur standard	Valeur maximum	Confirmer	Compteur	Quantité
Deutsch	Minimum Wert	Standard Wert	Maximum Wert	Sichern	Zähler	Fullmenge
Nederlands	Minimum waarde	Standaard waarde	maximum waarde	Bevestigen	Teller	Doseergroote
Svenska	Minimum värde	Standard värde	Maximalt värde	Bekräfta	Räknare	Kvantitet
Norsk	Minimum verdi	Standard verdi	Maksimum verdi	Bekreft	Telleverk	Mengde
Dansk	Minimum værdi	Standard værdi	Maksimum værdi	Bekræft	Tæller	Mængde
Suomi	Minimi arvo	Oletusarvo	Maksimi arvo	Vahvista	Laskin	Kahvimäärä
Español	Valor mínimo	Valor estándar	Valor máximo	Confirmar	Contador	Dosificación
Português	Valor mínimo	Valor standard	Valor máximo	Confirmar	Contador	Quantidade
Italiano	Valore minimo	Valore standart	Valore massimo	Passo	Contatore	Quantità
Ελληνικά	Ελάχιστη τιμή	Θυσιολογική τιμή	Μέγιστη τιμή	Επιβεβαίωση	Μετρητής	Ποσότητα
Česky	Minimální hodnota	Standardní hodnota	Maximální hodnota	Potvrdit	Počítadlo	Množství
Polski	Minimalna wartość	Standardowa wartość	Maksymalna wartość	Potwierdzenie	Licznik	Doza
Română	Valoare minimă	Valoare standard	Valoare maximă	Confirmare	Contor	Canțitate
Русский	Минимальный объем	Стандартный объем	Максимальный объем	Подтвердить	Счетчик	Порция
Türkçe	Minimum değer	Standart değer	Maksimum değer	Onayla	Sayaç	Miktar
中文	最小價值	標準價值	最大價值	計數器	確認	每壺份量
日本語	最小値	標準値	最大値	カウンタ	次のステップ	デカンター杯当りの量
한국	최소치	표준치	최대치	카운터	확인	데칸터당 량

Reading the total counter
Lecture du compteur total
Ablesen des Gesamtzählers
Uitlezen totaalteller
Avläsning av totalräkneverket

Avlesning av totaltelleren
Aflæsning af samlede tæller
Kokonaismäärälaskurin lukeminen
Lectura del contador total
Leitura do contador total

Letture del contatore totale
Ανάγωση συνολικού μετρητή
Uđaj o celkovém stavu počítadla
Odczyt całkowitego licznika
Citirea contorului total

СЧИТЫВАНИЕ ИТОГОВОГО КОЛИЧЕСТВА
Toplam sayaç okuma
 读取总计计数器
 合計カウンタの読み取り
 카운터 표시

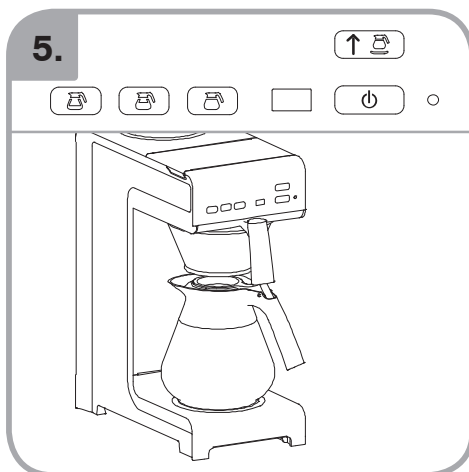
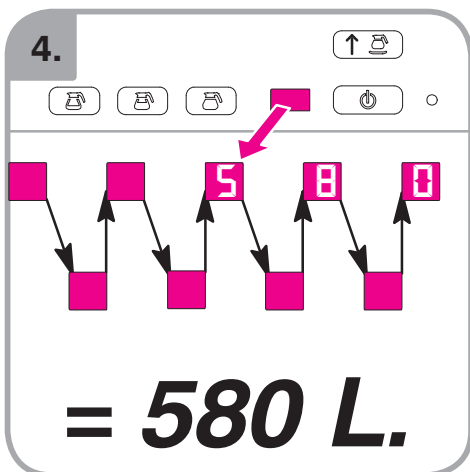
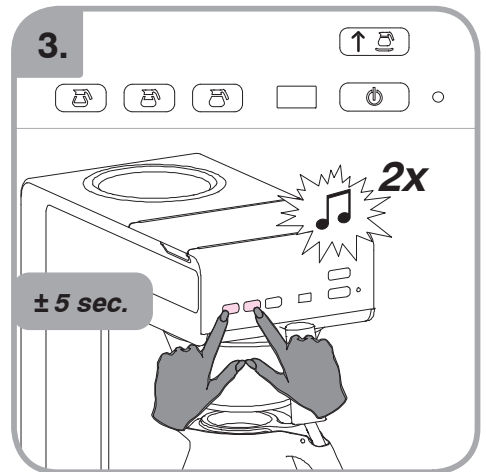
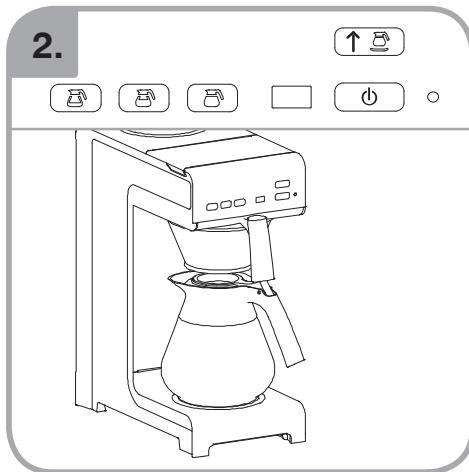
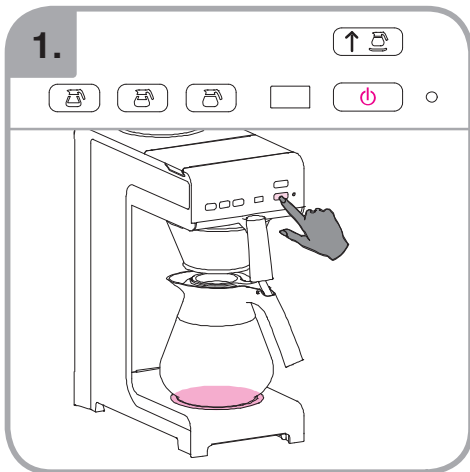

□ — 0 — ■ 65536

Setting the water quantity
 Réglage de la quantité d'eau
 Einstellung der Wassermenge
 Waterhoeveelheid instellen
 Inställning av vattenmängden

Innstilling av vannmengden
 Indstilling af vandmængden
 Veden määrän säätö
 Ajuste de la cantidad de agua
 Configuração da quantidade de água

Regolazione della quantità d'acqua
 Ρύθμιση ποσότητας νερού
 Nastavení množství vody
 Ustawienie jakości wody
 Setarea cantității apei

Установка количества воды
 Suurikvanti ayari
 水の品質の設定
 수량 설정

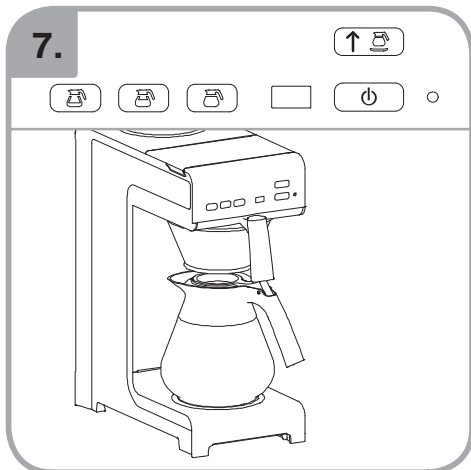
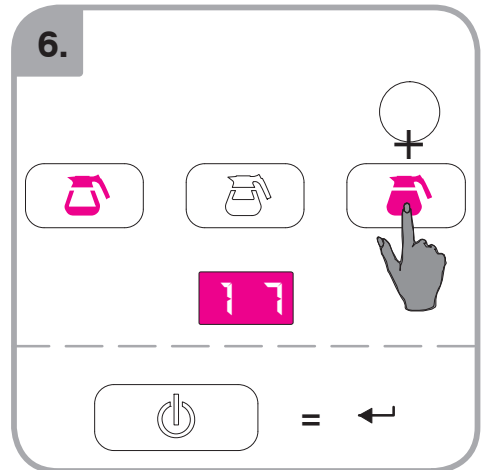
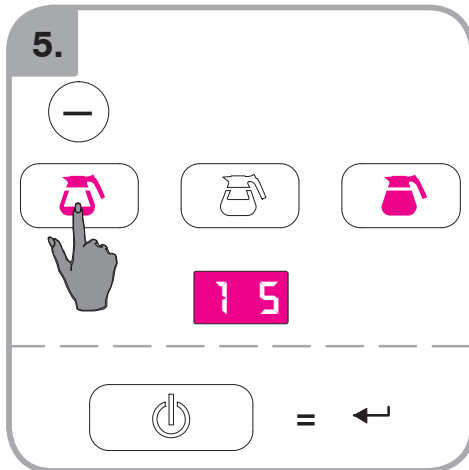
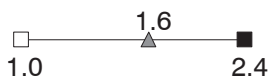
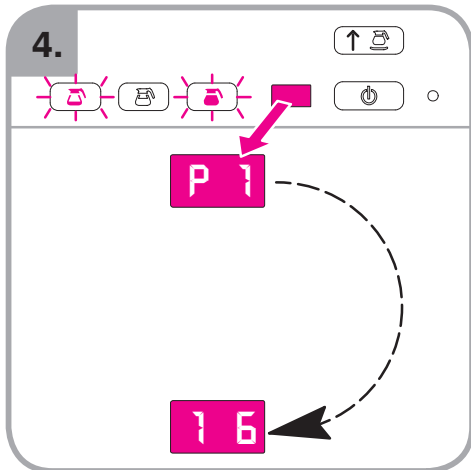
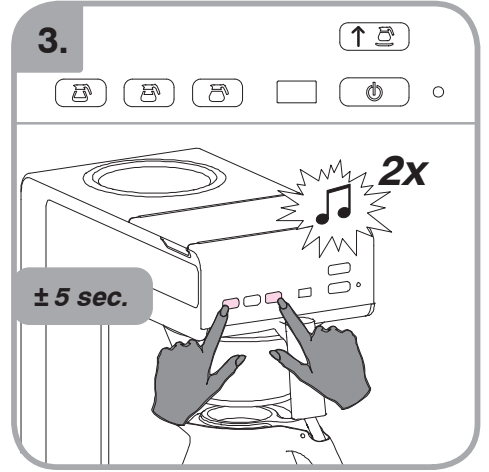
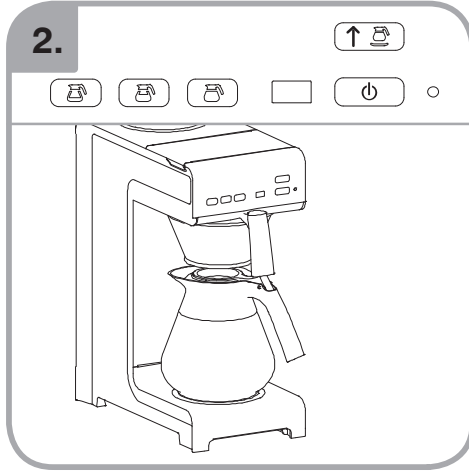
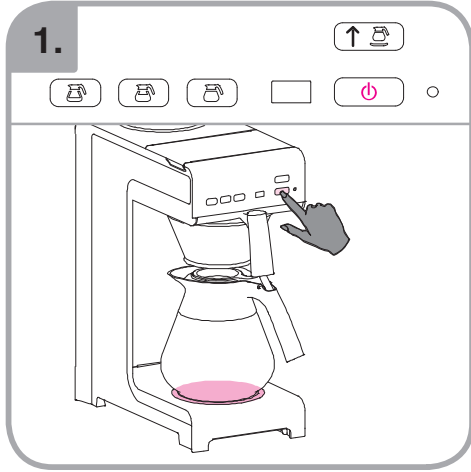

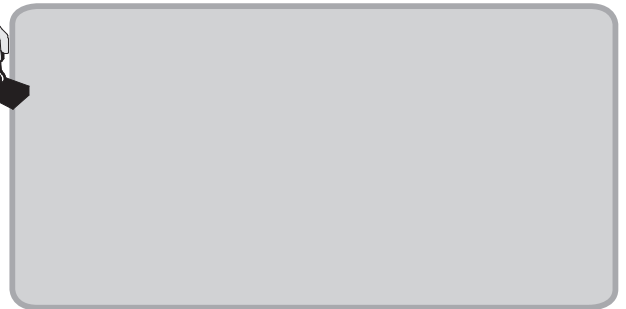
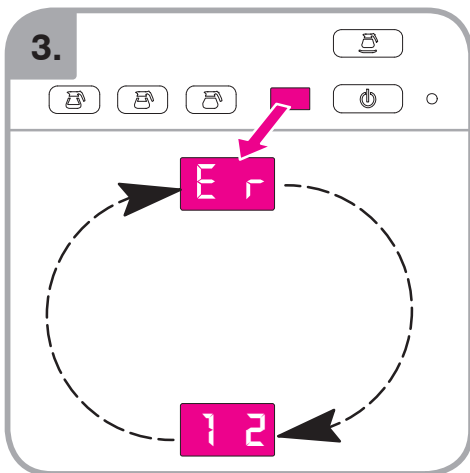
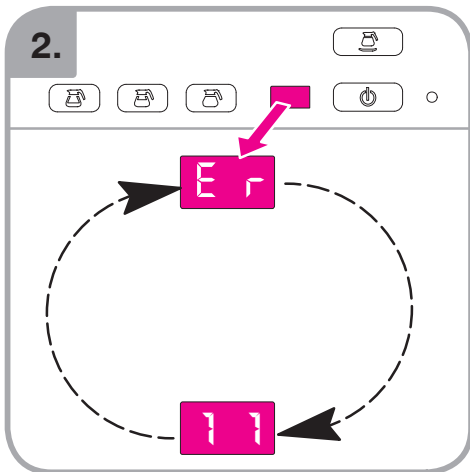
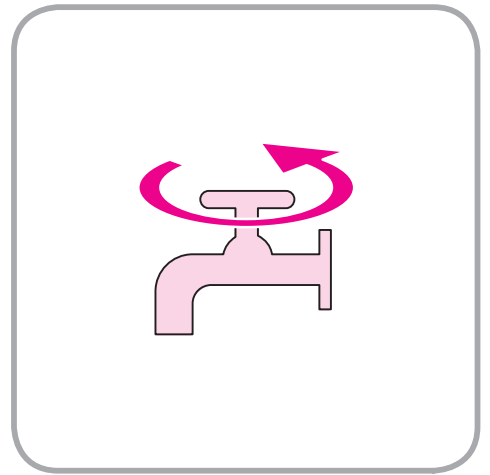
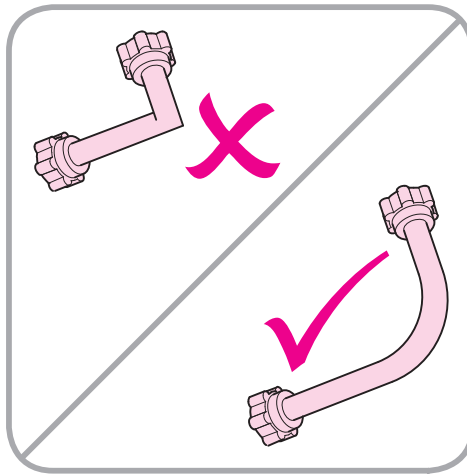
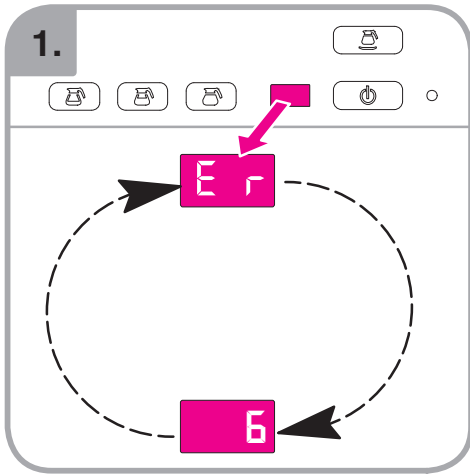

Matic

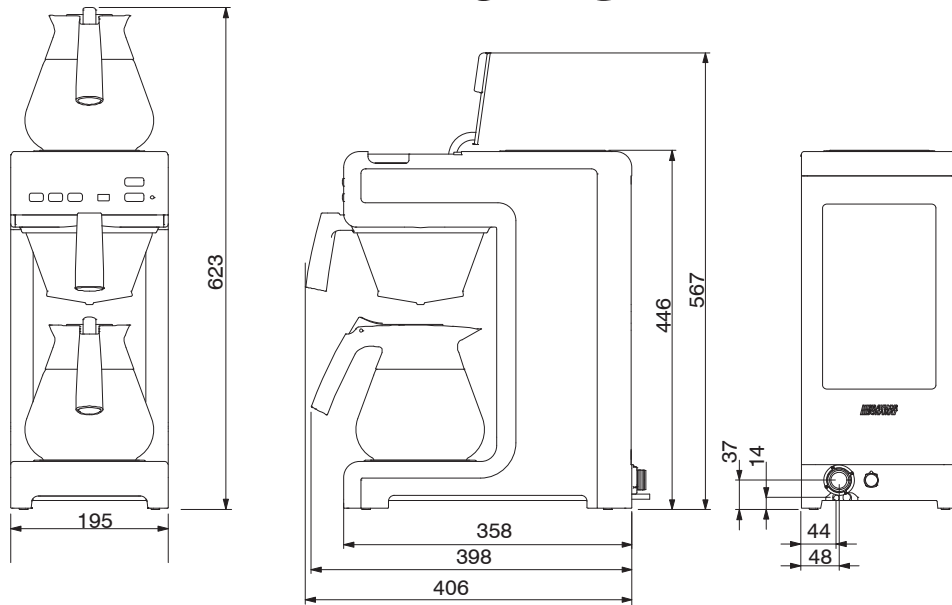

Matic Twin

